

SO2M

成光工業
 ブスバー・ジョイントIIタイ
 メッキ処理あり

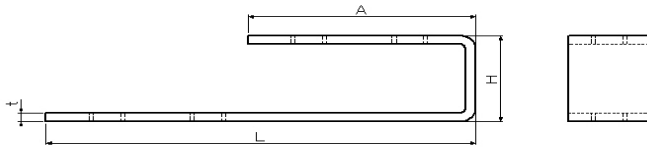
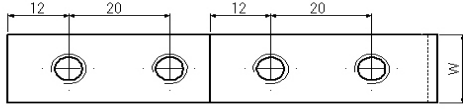
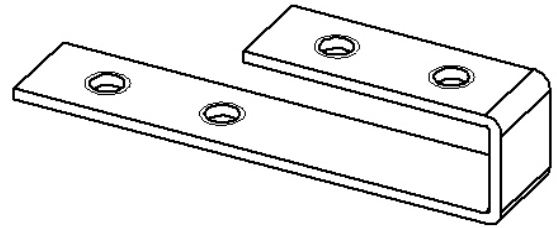
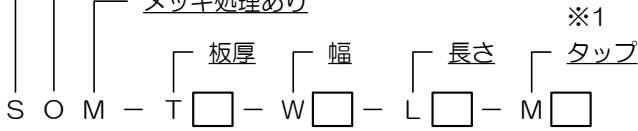

寸法		寸法			断面積	許容電流				
t	W	L	A	H						
2	12	85	45	20	24	50				
		105	65							
		125	85							
		145	105							
		165	125							
		185	145							
		205	165							
		225	185							
	15	245	205		30		75			
		265	225							
		85	45							
		105	65							
		125	85							
		145	105							
		165	125							
		185	145							
3	12	205	165	30	36	75				
		225	185							
		245	205							
		265	225							
		15	85				45	20	45	75
			105				65			
			125				85			
			145				105			
	165		125							
	185		145							
	205		165							
	225		185							
	30	245	205	30	75					
		265	225							

SO2M

成光工業
 ブスパー・ジョイントIIタイ
 メッキ処理あり

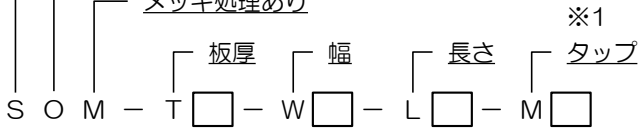

※1 タップ無しの場合は未記入。

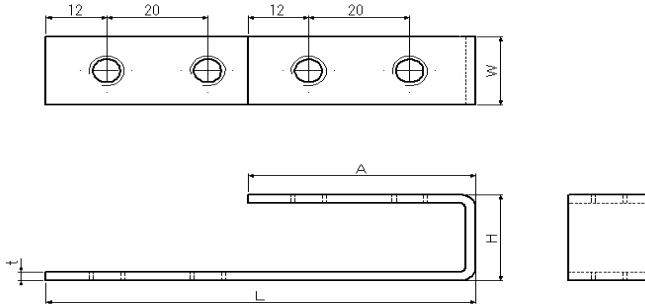
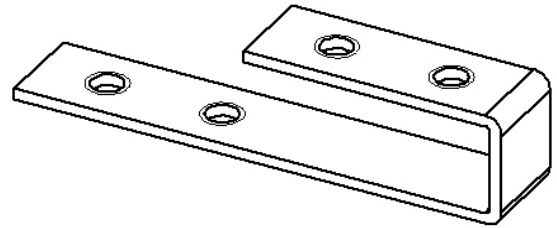

寸法			寸法		断面積	許容電流	
t	W	L	A	H			
4	12	85	45	30	48	75	
		105	65				
		125	85				
		145	105				
		165	125				
		185	145				
		205	165				
		225	185				
	245	205	40				
	265	225					
	15	85		45			30
		105		65			
		125		85			
		145		105			
		165		125			
		185		145			
205		165					
225		185					
245	205	40					
265	225						
5	12		85	45	30	60	100
			105	65			
			125	85			
			145	105			
			165	125			
			185	145			
		205	165				
		225	185				
	245	205	40				
	265	225					
	15	85		45	30		
		105		65			
		125		85			
		145		105			
		165		125			
		185		145			
205		165					
225		185					
245	205	40					
265	225						